

TARGET

CNC
Turning Center

LH 208

Turning 30 years
of experience into perfection

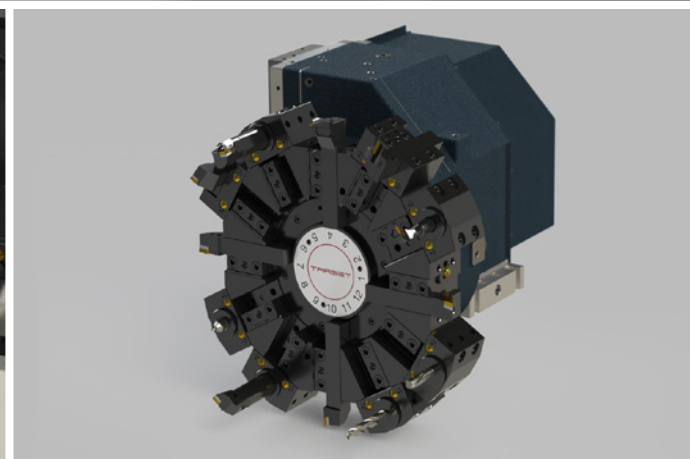
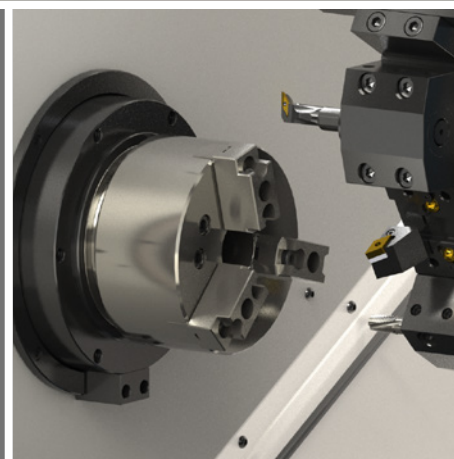

SPECIFICATIONS

Item	Unit	LH 208
Capacity		
Turning Diameter (Max)	mm	Ø330
Turning Length (Max)	mm	440
Bar Capacity (Max)	mm	Ø50
Swing Over Cross Slide	mm	Ø340
Swing Over Way Covers	mm	Ø600
Main Spindle		
Spindle Nose	ASA	A2-6
Spindle Bore Diameter	mm	Ø62
Spindle Bearing Diameter (Front)	mm	Ø100
Chuck Size (Standard)	mm	Ø210
Spindle Speed (Standard/Option)	rpm	4000/2500
Spindle Power Continuous (30 min)	kW	7.5 (11.0)
Turret		
Type: Servo Index w/ Hydraulic Clamping		Slotted Tool Disc
No. of Tool Stations		12
Turning Tool Shank Size	mm	25 x 25
Boring Bar Diameter (Max)	mm	Ø40
Index Time (1 Station)	s	0.9
Index Time (180°)	s	1.6
Live Tooling		
No. of Live Tool Mounting Stations (Max)		
Live Tool Type		
Speed (Max)	rpm	Refer Model: LH 208M
Power (Max)	kW	
Torque (Max)	Nm	
Feed Drives		
X Axis Rapid Traverse	m/min	30
Z Axis Rapid Traverse	m/min	30
X Axis Stroke	mm	190
Z Axis Stroke	mm	440
Type of Guide Ways - X & Z Axes		LM Guides
Tailstock		
Quill Diameter	mm	Ø80
Quill Taper Size		MT-4
Quill Thrust (Max)	kg	500
Quill Stroke	mm	80
Tailstock Base Travel	mm	450
Type of Guide Ways		V & Flat
C Axis		
Least Programmable Value	deg	Refer Model: LH 208M
Rapid Traverse (Max)	rpm	
Accuracies		
Spindle Nose Run-out TIR (Max)	mm	0.005
Positioning Accuracy - X & Z Axes	mm	±0.010
Repeatability - X & Z Axes (Max)	mm	0.005
Machine Size and Power		
Length (w/o Chip Conveyor)	mm	2805
Height	mm	1804
Width	mm	1763
Height of Spindle Center	mm	1018
Weight	kg	3700
Power (w/o Options)	kVA	20
Control		
CNC System		FANUC/Mitsubishi/Siemens
Axis Drive		AC Digital Servo
Spindle Drive		AC Spindle Servo

Due to continuous improvements in design, the specifications are subject to change without notice.

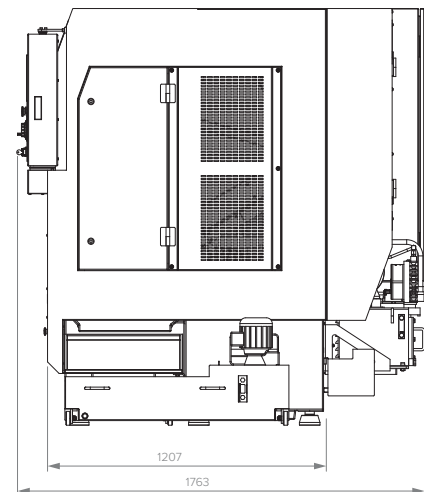
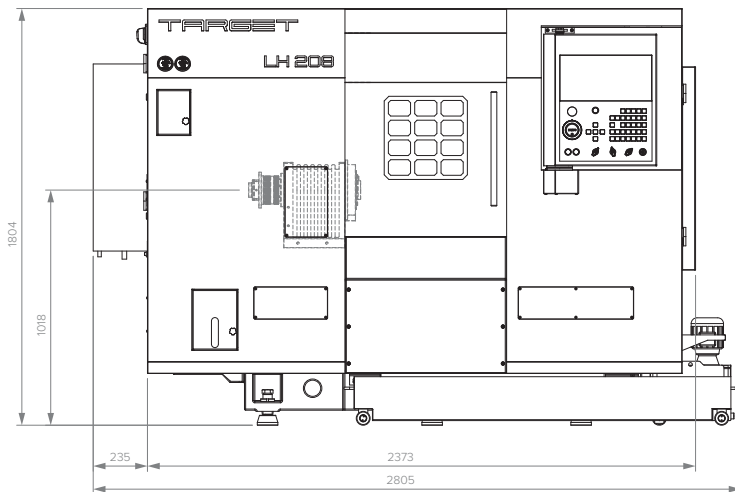
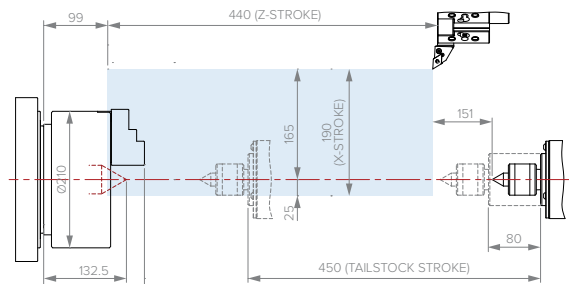
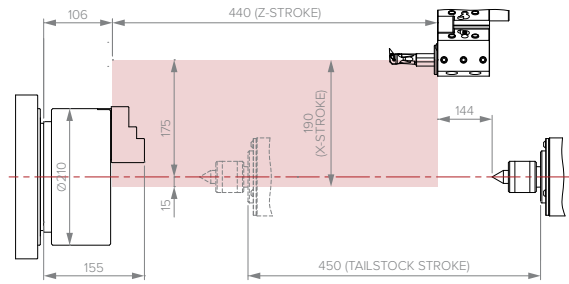
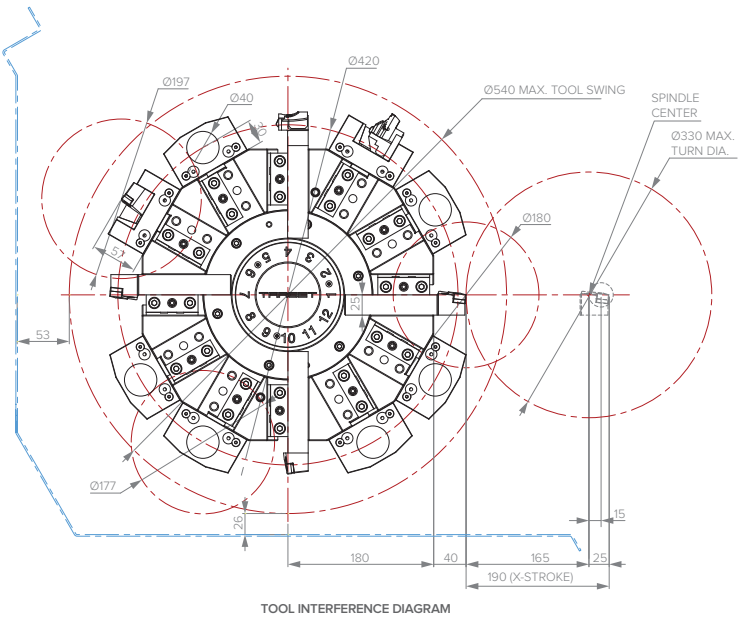

Other Variants	CNC Turning Center LH 206, CNC Turning Center LH 210, CNC Turn-Mill Center LH 206M, CNC Turn-Mill Center LH 208M, CNC Turn-Mill Center LH 210M
-----------------------	--

Machine Options	Parts Catcher, Chip Conveyor, Steady Rest, Bar Puller, Bar Feeder
------------------------	---